



Massskizze

Bei Fragen und Anregungen stehen wir Ihnen gerne zur Seite:

Faserplast AG

Sonnmattstrasse 6-8
9532 Rickenbach TG

Tel. 071 929 29 29
Mail: info@faserplast.ch
www.faserplast.ch

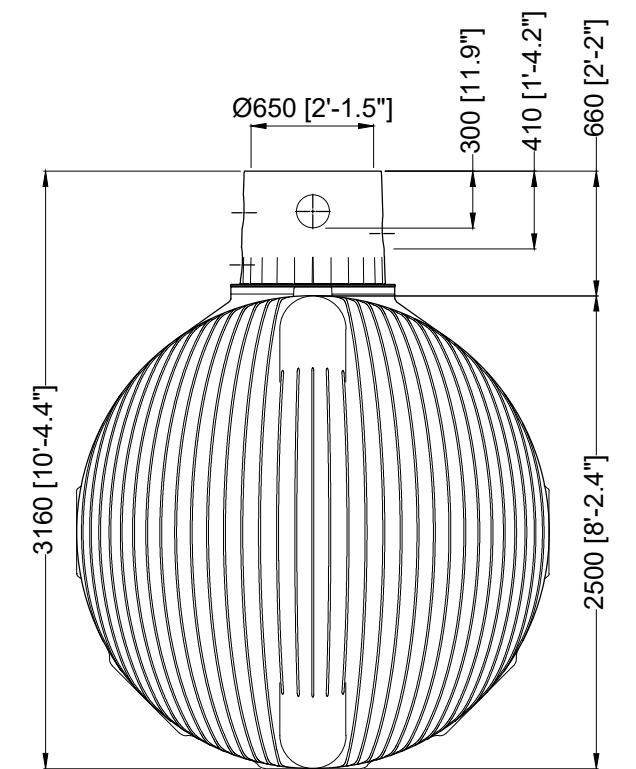
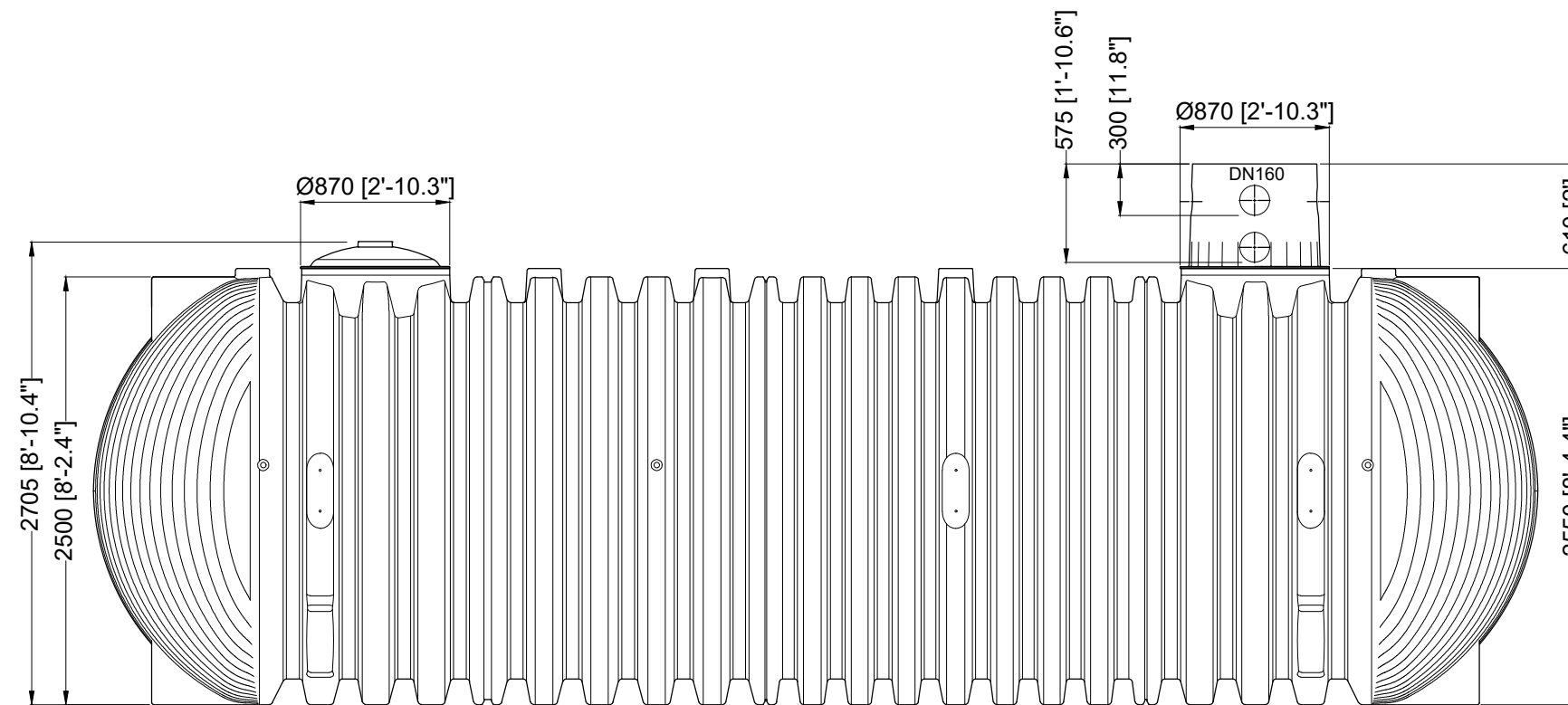
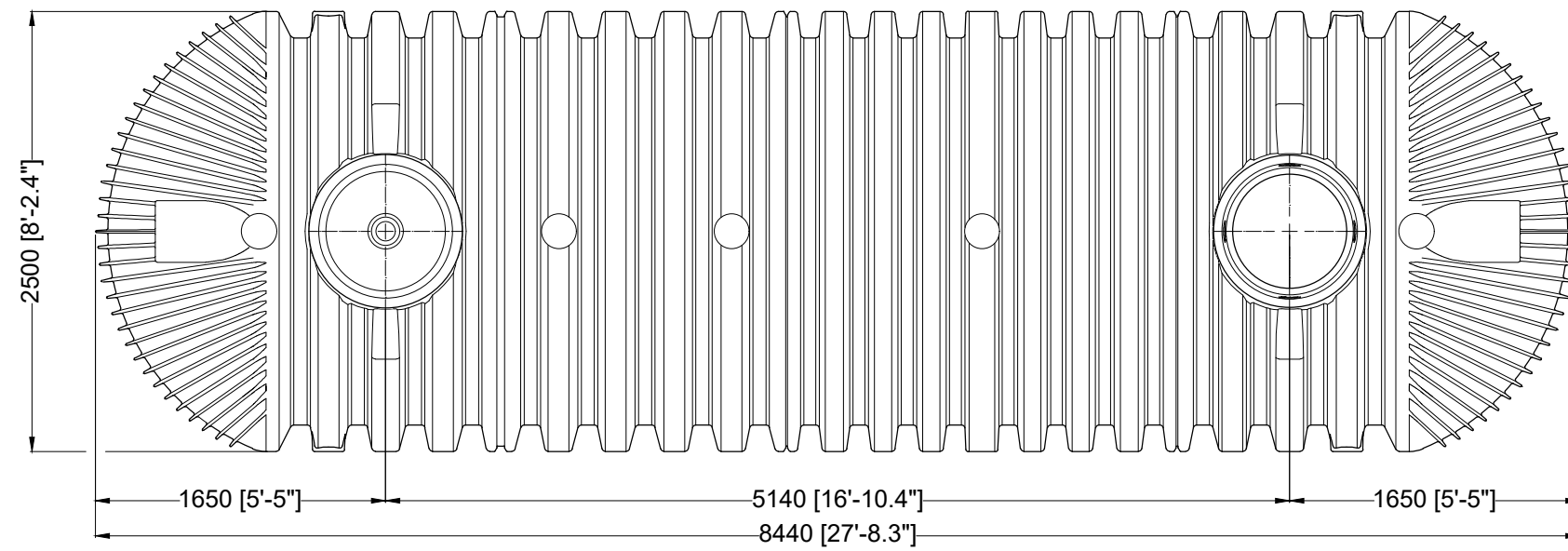

D GRAF Regenwasser-Erdtank Carat XXL 32000 L / 8454 gal.			Artikel-Nr. product no. 380003 article no. (380814 / 371018 / 371065) articulo no.
GB GRAF underground tank Carat XXL 32000 L / 8454 gal.	ES GRAF Depósito soterrado Carat XXL 32000 L / 8454 gal.	FR GRAF Cuve à enterrer Carat XXL 32000 L / 8454 gal.	revision
gezeichnet drawn EMU	Gewicht weight 1375 kg	Otto Graf GmbH Carl-Zeiss-Str. 2-6 DE-79331 Teningen mail@graf.info www.graf.info	
Datum date 2020.08.10	Toleranz tolerance +/- 3%		
Maßstab scale M 1:40	Einheiten units mm [inch] gal. = US gal.		

